





# TABLE OF CONTENTS

About Sauna Therapy .....	3
Safety Precautions .....	5
Disclaimer .....	9
Luminati® & Faraday® Saunas	
Parts List .....	10
Specifications .....	14
Assembly .....	15
Tungsten™	
Parts List .....	26
Specifications .....	27
Assembly .....	28
Shower Sauna Conversion Kit	
Parts List .....	30
Specifications .....	32
Assembly .....	33
Operations .....	38
Maintenance .....	42
Returns .....	43
Warranty .....	45

## ABOUT SAUNA THERAPY

Throughout history, humans have used sauna therapy—also known as hyperthermic therapy—as a safe and powerful way to detoxify. Saunas heat the body, dramatically increasing blood flow to the vital organs and skin, and activate built-in cellular detox and repair functions. Unlike active exercise, sweating in a sauna allows your body to focus on healing and detoxification because your body’s energy is not being used for movement.

### The near infrared advantage

---

Near infrared (NIR) sauna therapy uses the science of light to improve your wellness, including mind and body.

#### **Deep tissue penetration**

NIR can penetrate up to 9 inches into the body, meaning it goes beyond skin deep to give you results from the inside out. You’ll experience faster and more comprehensive benefits compared to saunas using primarily far infrared technology.

#### **Light Therapy**

NIR includes a range of wavelengths that are absorbed by special receptors in your body called mitochondrial photoreceptor proteins. So when you use your SaunaSpace® sauna, you’re benefiting from heat and light therapy in one device.

#### **Safe and efficient**

Our incandescent near infrared bulbs are energy efficient and feature the sun-centric red and NIR light spectrum our bodies crave. You get all the benefits of light and heat therapy with none of the UV exposure.



For your safety and enjoyment, read this user manual carefully before using your SaunaSpace® product.

## SAFETY PRECAUTIONS

### Operation precautions

---

- **Keep water, liquid, or metal from directly touching bulbs to avoid a rupture that could cause injury, fire, or property damage.**
- Keep this user manual for future reference.
- Limit use to one 20-minute session per day to start.
- Only turn on your Tungsten™ sauna panel for preheating or during sessions.
- Turn off and unplug your Tungsten™ sauna panel immediately after use.
- Rotate your body 90 degrees every 2–10 minutes to avoid uneven results or overexposure.
- Remove bulbs from the sauna panel before moving, assembling, disassembling, or cleaning your sauna components.
- Fire risk: Keep combustible objects and materials, including the sauna cover, at least 36 inches from front of bulbs.
- Burn risk: Do not touch bulbs during or immediately after use.
- Do not stare directly into bulbs during operation.
- Do not use this product while lying down without supervision. Make sure that you are awake at all times while using this product.
- Close your eyes when directing the Tungsten™ sauna panel towards your face.
- Only use the Tungsten™ sauna panel with bulbs pointed in a horizontal or upward direction. Never orient the bulbs downward, as per the illustration on the next page.

## Sauna panel orientation

---

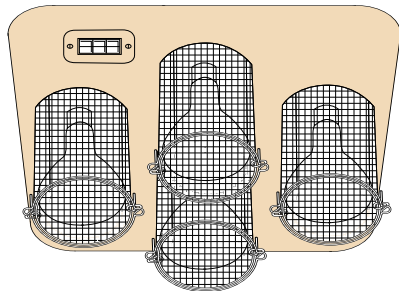
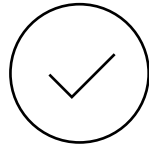
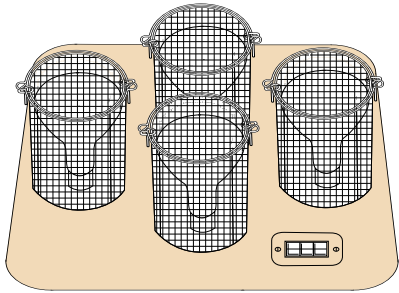
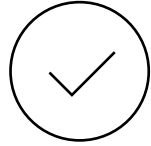
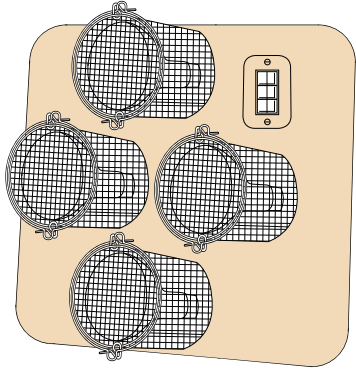

Fire hazard

## Sauna panel clearance

---

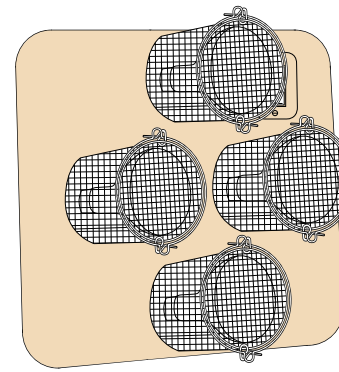

36"

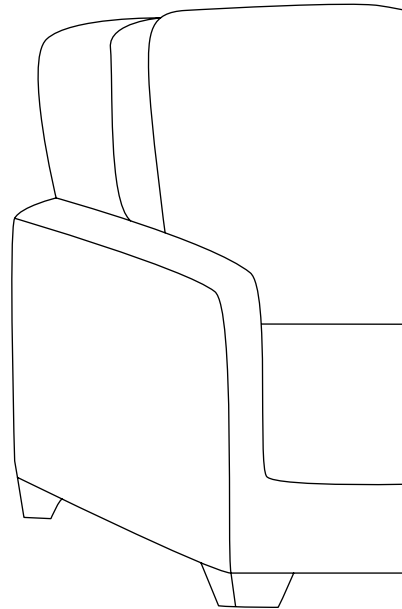

Keep combustible objects and materials at least 36 inches from the front of your Tungsten™ sauna panel while it is in use to minimize fire risk.



## Electrical precautions

---

- Do not plug your sauna into an overloaded or ungrounded outlet.
- Do not touch the sauna panel or power cord if you are wet.
- Keep power cords out of the way to avoid walking on or damaging them.
- Always inspect power cord, sauna panel, and bulb sockets before use.
- If any parts of the sauna panel appear damaged, immediately turn off the panel, unplug it from the power source, and contact SaunaSpace® customer service for repair and/or replacement.

### Power supply requirements

The sauna panel is intended for use with a grounded three-conductor power socket. It is rated for 1000 W max. Only use this product with a minimum 13 A (maximum 20 A) grounded electrical outlet with 50/60 Hz 110–240 VAC voltage.

### Bulb voltage

120 V bulbs may only be used with a 110–120 V power supply. 240 V bulbs may only be used with a 220–240 V power supply.

## Health precautions

---

- Consult your health care provider before use.
- Sauna use is not appropriate for infants or people with certain disabilities.
- Sauna use is not appropriate if you are invalid, pregnant, sleeping, unconscious, under the influence of alcohol or illicit drugs, or otherwise unable to avoid potential injury.
- If you have any type of implant or take prescription medication, consult your health care provider before use.
- Children should never operate the sauna, and should only use the sauna with adult supervision and approval from a health care provider.
- Hyperthermia risk: do not allow your body's core temperature to exceed 103 °F (39.4 °C).

## Healing reactions

---

Sometimes people experience healing reactions during their first few sauna sessions. It is a natural response to detoxification, and may include temporary moodiness, nausea, tastes, odors, or fatigue that typically goes away right after the session. You may also be dehydrated from fluid loss during your session. Drinking one or two glasses of water before and after may help. If symptoms persist, see your doctor.

### Disclaimer

Always consult a licensed health care provider before using a sauna, and consider monitoring your progress with a professional trained in sauna use. Before using a sauna, educate yourself about the preparation, operation, and risks of sauna therapy.

Variables such as your health, duration of sauna use, hydration levels, electrolyte levels, and mineral balance can impact risk. Talking to your health care provider can help identify these concerns or others associated with medications, health conditions, and more.

Saunas are powerful devices that should be used with care and caution. Risks include dehydration, headache, nausea, weakness, rashes, hot flashes, fainting, exacerbation of neurological symptoms, stroke, cardiac failure, and death.

SaunaSpace® Products are not registered with the United States Food and Drug Administration (FDA) as medical devices. Consult your licensed health care provider to see if SaunaSpace® Products are right for you. SaunaSpace® and its partners, associates, etc. are not liable for the use of SaunaSpace® Products nor any incidental or consequential damages. Under no circumstances shall SaunaSpace® Products or any of its representatives be held liable for injury to any persons or damage to any property. If your state does not allow exclusion or limitation of incidental or consequential damages, these restrictions may not apply to you.

SaunaSpace® Products are not intended to diagnose or treat any disease or medical problems and are not a substitute for regular medical care from a licensed physician.

# PARTS LIST - Sauna

## Tungsten™ Infrared Sauna Panel

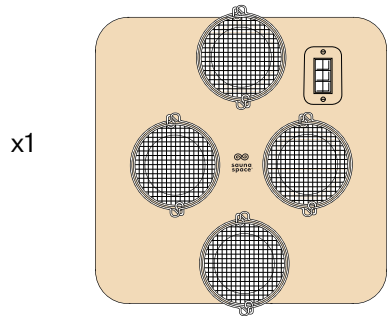

x1

**Tungsten™ Infrared Sauna Panel**  
23.75 x 23.5 x 9 in  
(60.3 x 59.7 x 22.9 cm)



x4

**ThermaLight® Infrared Bulbs**  
120 V or 240 V

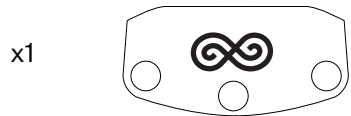

x1

**Power cord grounding sleeve**

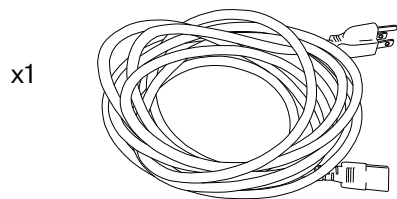

x1

**Shielded power cord**  
15 ft (4.6 m)

## Sauna Enclosure Kit



x4

**Long pole halves - male thread**  
30.875 in (78 cm)



x4

**Long pole halves - female thread**  
30.875 in (78 cm)



x6

**Short pole halves - male thread**  
23.125 in (59 cm)



x6

**Short pole halves - female thread**  
23.125 in (59 cm)

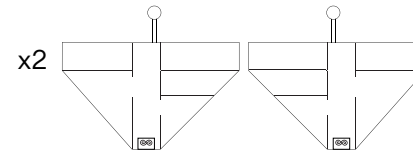

x2

**3-way frame connectors**  
17.25 x 9.5 in  
(44 x 24 cm)

(left) (right)

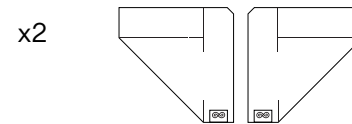

x2

**2-way frame connectors**  
9.625 x 9.625 in  
(24 x 24 cm)

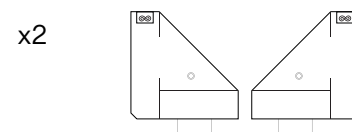

x2

**2-way frame connectors w/snap (rear)**  
9.625 x 9.625 in  
(24 x 24 cm)

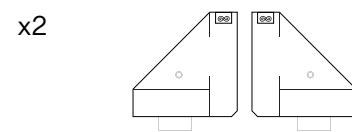

x2

**2-way frame connectors w/snap (front)**  
9.625 x 9.625 in  
(24 x 24 cm)

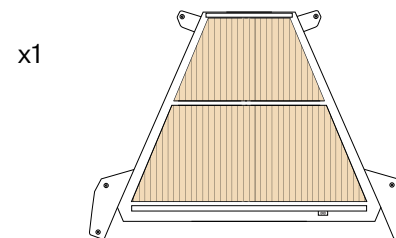

x1

**Bamboo grounding mat**  
49.325 x 48.125 x 22.75 in  
(125 x 122 x 58 cm)  
front width x depth x rear width

## Sauna Enclosure Kit (Continued)

---

x2  **Long grounding mat sticks**  
24.75 in (63 cm)

x1  **Short grounding mat stick**  
22.75 in (58 cm)

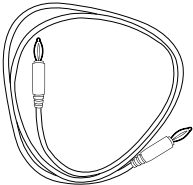
x1  **Grounding cable**  
3.3 ft (1 m)

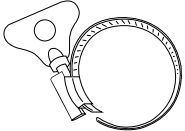
x4  **Turnkey mounting clamp**

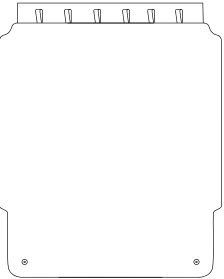
x1  **Regular sauna curtain**

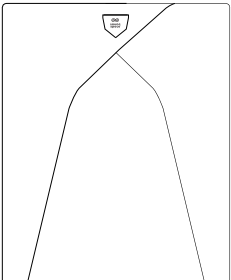
x2  **Sauna covers (outer cover with pocket)**

## Faraday®-Only Items

---

If you purchased a Luminati® sauna, these items will not be in your shipment, but they can be purchased as an upgrade later.

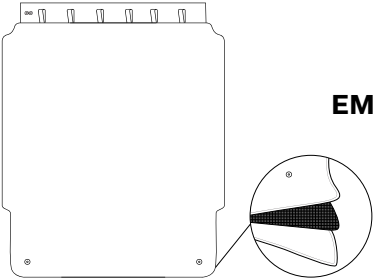
x1  **EMF shielding curtain**

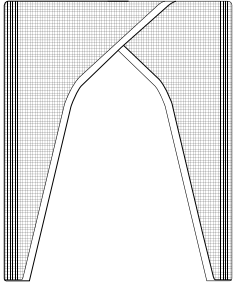
x1  **EMF shielding cover**

## Sauna Stool

---

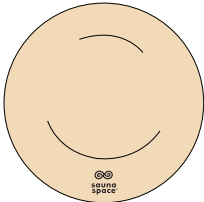
x1  **Seat plate**

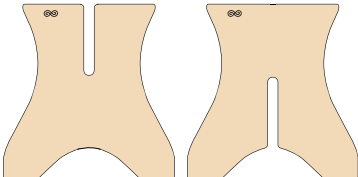
x2  **Leg panels**

# SPECIFICATIONS

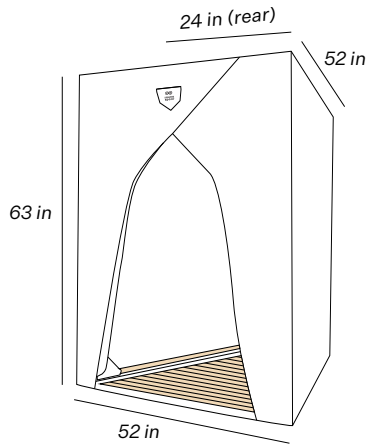

## Weight

Total: 52.7 lb (23.9 kg)  
Tungsten™ Sauna Panel: 11.4 lb (5.2 kg)  
Frame Poles: 6.6 lb (3 kg)  
Grounding Mat: 3.4 lb (1.5 kg)  
Sauna Stool: 8.5 lb (3.9 kg)  
Cover Set: 21 lb (9.5 kg)  
EMF Shield Cover: 1.8 lb (0.8 kg)

## Assembled dimensions

Entrance width: 52 in (132 cm)  
Rear width: 24 in (61 cm)  
Depth: 52 in (132 cm)  
Height: 63 in (160 cm)

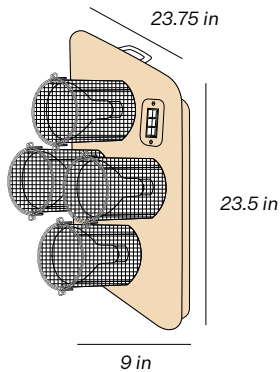

## Tungsten™ Sauna Panel dimensions

Width: 23.75 in (60.3 cm)  
Height: 23.5 in (59.7 cm)  
Depth: 9 in (22.9 cm)

## Electrical info

Wattage: 250 W  
Input voltage and frequency:  
120 V at 50–60 Hz, 240 V at 50–60 Hz

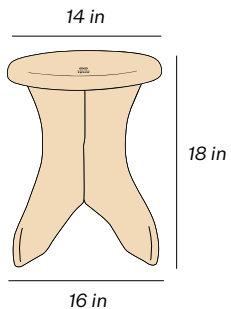

## Sauna Stool dimensions

Height: 18 in (46 cm)  
Seat width: 14 in (36 cm)  
Leg width: 16 in (41 cm)

## Approvals

All electrical parts UL-listed  
CE-certified

# ASSEMBLY - Sauna

For video instructions, visit <https://go.sauna.space/sauna-setup>

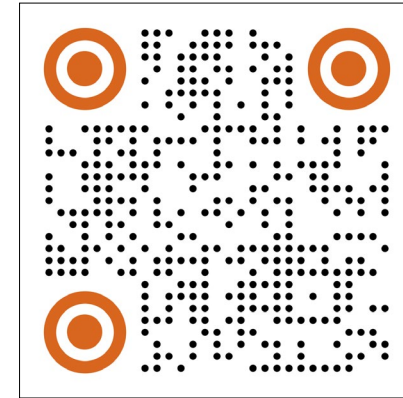

Part 1: Use your bamboo grounding mat to find a place for your sauna.

---

1. Remove the mat from the box.
2. Lay out the mat in your desired sauna location to confirm adequate space.
3. Slide 2 long grounding mat sticks into the sleeve at the front of the bamboo grounding mat and slide 1 short grounding mat stick into the sleeve at the rear.

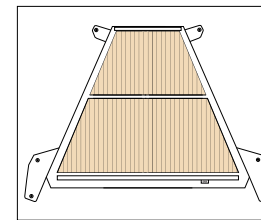

Step 2

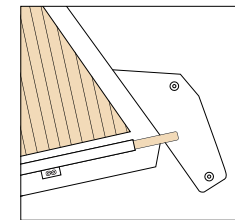

Step 3

## Part 2: Sauna panel

---

- Carefully set the Tungsten™ Infrared Sauna Panel on the grounding mat, bulb side down.
- Slide the clamp belt through a mounting slot on the back of the panel.
- Push the end of the clamp belt beneath the turnkey.
- Twist the turnkey clockwise several times to thread it onto the end of the clamp belt. Do not tighten it yet.
- Repeat with the remaining three mounting clamps.

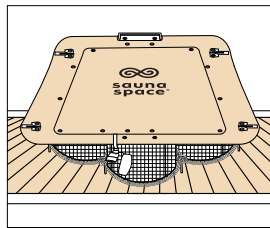

Step 4

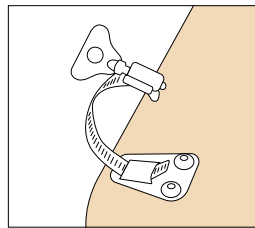

Step 5

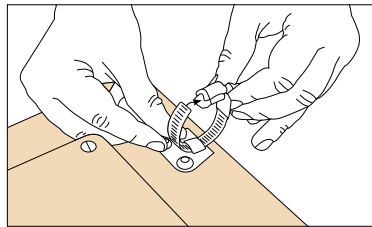

Step 6

## Part 3: Frame

---

- Assemble all the long pole halves together by screwing the male half into the female half. Repeat with all the short pole halves.
- Slide two long poles vertically through the mounting clamps on the back of the panel.
- Center the poles over the panel.
- Twist turnkeys clockwise to tighten each clamp until it is snug. Do not overtighten.

- Flip the panel so it is facing up.
- Place a 2-way connector (without snap) over the top of each pole. The longer socket goes over the pole. The SaunaSpace® logo faces the outside of the sauna on each connector.
- Place a 2-way connector **with snap** over the bottom of each pole. The longer socket goes over the pole, with snaps facing the outside and tabs facing down.
- Insert a short pole in the two bottom connectors.
- Place a 2-way connector **with snap** over the other end of each short pole. The shorter socket goes over the pole, with snaps facing the outside and tabs facing down.

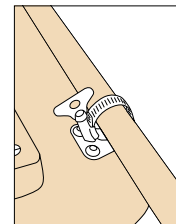

Step 10

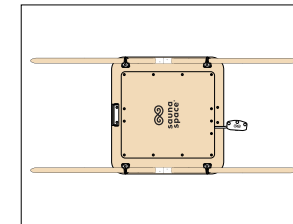

Step 11

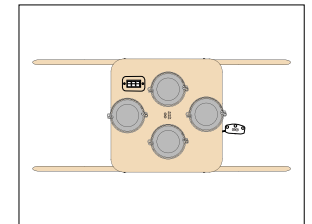

Step 13

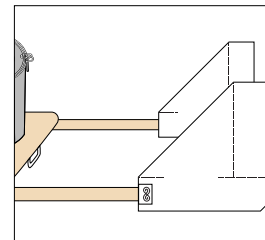

Step 14

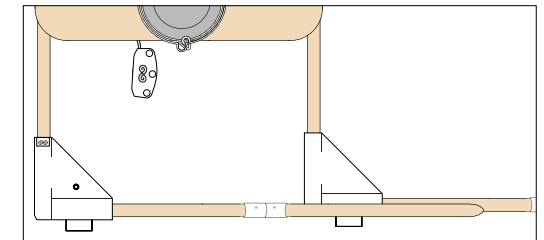

Step 16

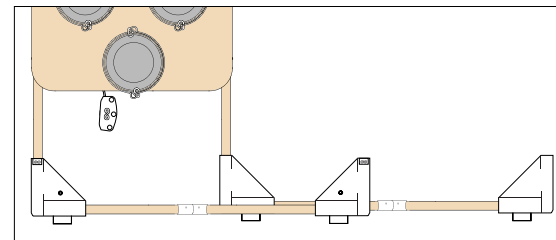

Step 17

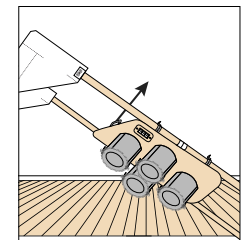

Step 18 (next page)

18. Use the handle on the back of the panel to carefully stand it upright. Rotate the legs outward for improved stability.
19. Place grounding mat between the poles at the bottom of the frame.
20. Pull grounding mat flaps to the outside of the frame.
21. Insert each frame connector tab underneath the lips of the grounding mat. Start inserting the rear connectors first, then insert the front connectors after.
22. Snap the grounding mat flaps to the outside of each frame connector.
23. Insert a long pole into the long socket of a 3-way connector.
24. Insert the other end of this long pole vertically into the 2-way connector at the bottom of the frame.

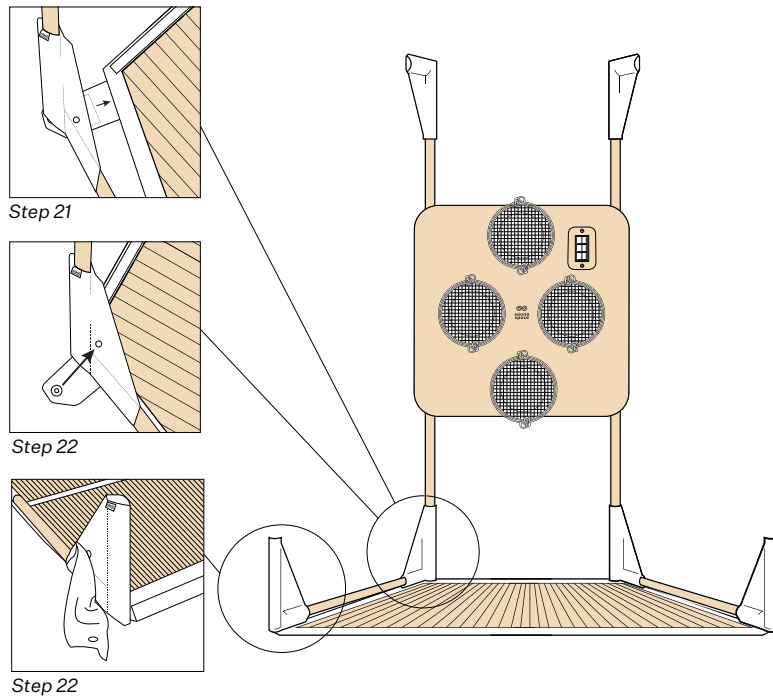

25. Insert a short pole into the 3-way connector, and then insert the other end of this short pole horizontally into the 2-way connector above the sauna panel forming one side wall. Now, the double socket of the 3-way connector is pointed across the front of the sauna.
26. Repeat with the other side.
27. Connect the two sides at the front with a short pole in the top sockets.
28. Hang the curtain on the remaining short pole using the side with six loops.
29. With the six loops facing outside, insert the short pole into the last remaining socket on the front of the frame. You may need to pull one of the top connectors out slightly for this step.
30. Double check that all poles are firmly inserted into frame connectors.

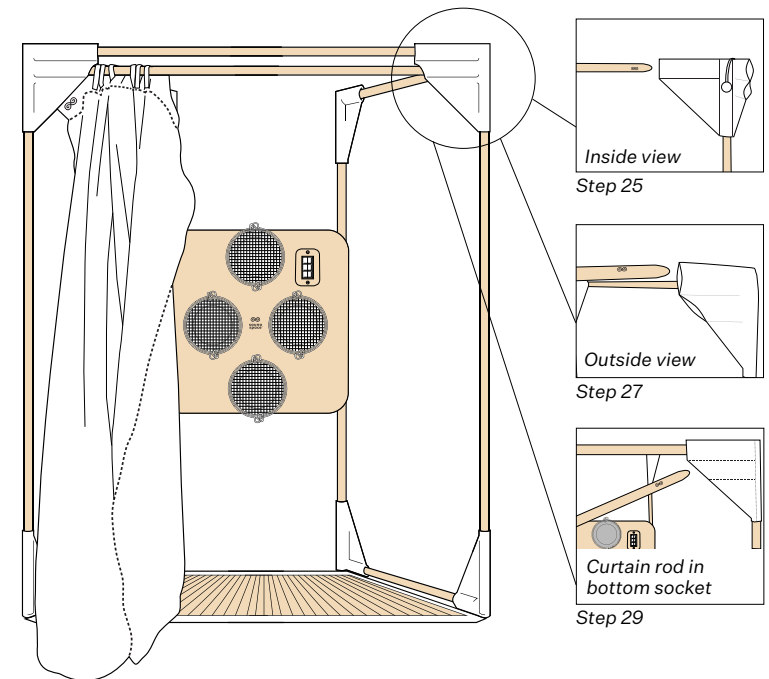



## Part 4: Stool

---

31. Set the seat plate on the floor with the x-groove facing up.
32. Align the slots on the leg panels. The two panels should be perpendicular.
33. Press down to attach the leg panels to each other.
34. Set the assembled leg panels into the x-groove on the seat plate and press down.
35. Turn the stool right side up and press firmly down on seat plate to ensure leg panels are fully inserted into x-groove.

**Note:** If the stool wobbles, the leg panels may not be fully inserted. Turn the stool upright and tap it firmly on the ground to attach the seat plate fully.

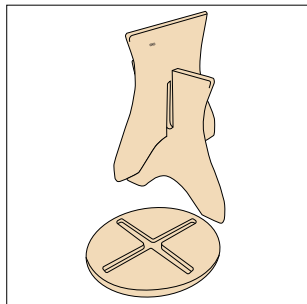

Step 32

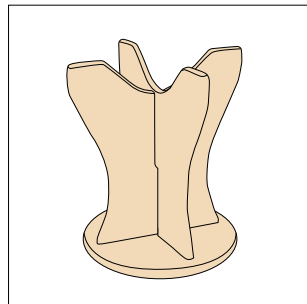

Step 34

## Part 5: Height adjustments

---

36. Place the stool in the center of the sauna.
37. Sit down to determine if the sauna panel is at the right height for your torso. The bottom of the panel should be approximately level with your knees.
38. To adjust the panel height, loosen the lower two turnkey clamps, hold the handle on the panel, then loosen the top clamps just enough to slide the panel.
39. Carefully adjust and retighten the clamps.

## Part 6: Cover

---

40. Drape the inner cover (without embroidered pocket) over the sauna with the seams inside
41. Tuck the bottom of the cover underneath the lower corners of the frame, beginning with the back of the sauna. The cover should be relatively smooth and fitted across the frame.

**Note:** After installing, the hideaway pocket sewn into the inside of the inner cover will be inside the sauna below the panel.

**42. If you purchased a Faraday® sauna or the EMF Shield upgrade,** install it now, using the same procedure as the inner cover.

43. Install the outer cover (with embroidered pocket) using the same procedure as the inner cover.

Inner cover

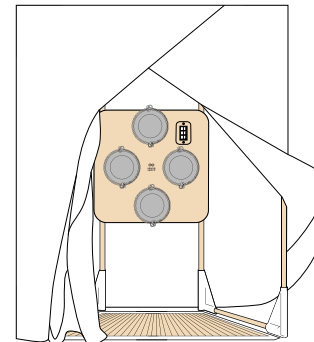

Step 40-41

EMF Shield - Faraday only

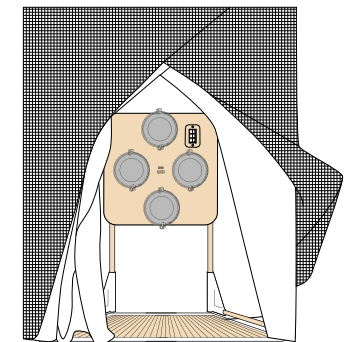

Step 42

Outer cover

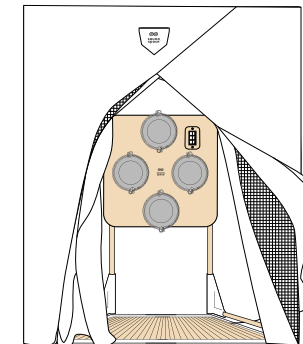

Step 43

## Part 7: Cord management

---

44. Open the cord sleeve attached to the sauna panel.
45. Firmly attach the power cord and grounding cable and close the sleeve.
46. Feed the other end of the power cord and grounding cable into the hideaway pocket in the inner cover of the sauna, right behind the cord sleeve.
47. At the bottom of the hideaway pocket, find the end of the power cord and the grounding cable.
48. Push the end and extra length of the power cord outside the sauna through the slits at the bottom of each cover layer.

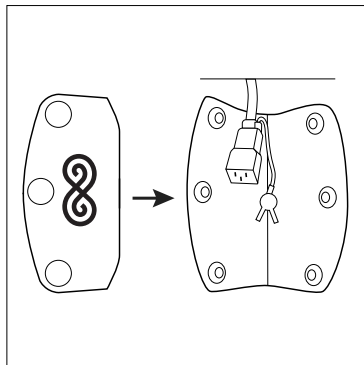

Step 44

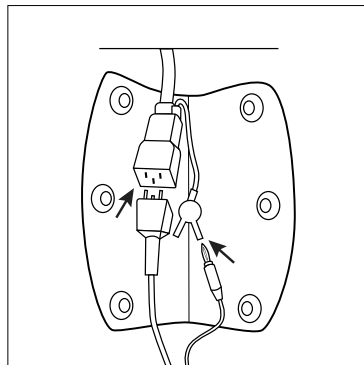

Step 45

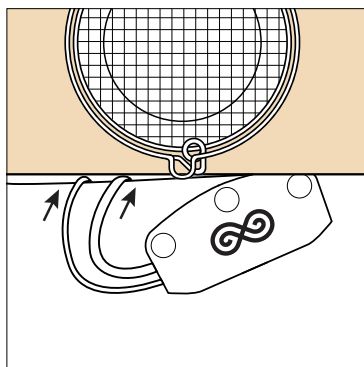

Step 46

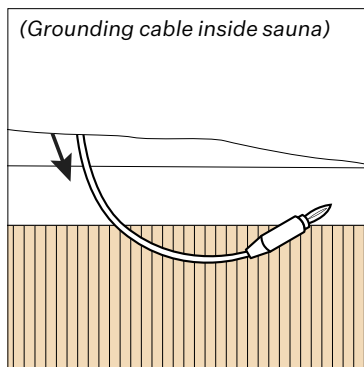

Step 47

## Part 8: Grounding cable

---

49. Reach underneath the back of the grounding mat to find the double-pronged grounding jack.
50. **If you purchased the Faraday® sauna or EMF Shield upgrade,** reach through the cord opening and pull out the grounding strap attached to the EMF Shield layer. Unsnap the jack on the grounding mat and snap the grounding strap on the EMF Shield in its place.
51. Connect the grounding cable to the grounding jack. The second prong of the jack isn't used during normal setup.\*

\*The second prong of the grounding jack creates a dedicated external ground if your outlet is not grounded. If this applies to you, contact [hello@sauna.space](mailto:hello@sauna.space) for assistance.

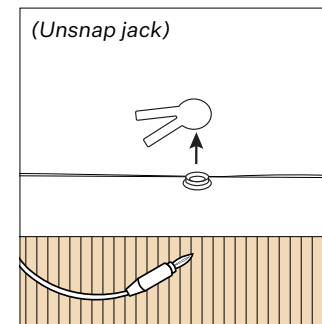

Step 50

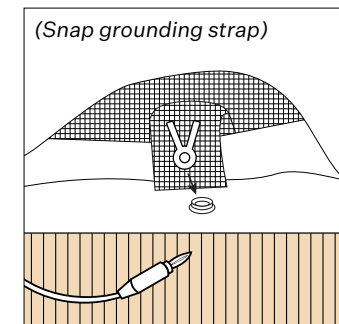

Step 50

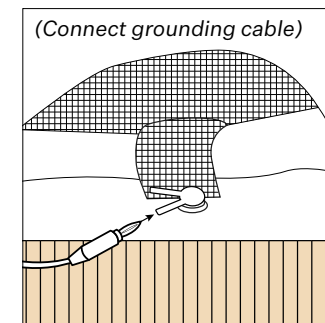

Step 51

## Part 9: Bulb installation

---

52. On the sauna panel, open the bulb guard basket by holding the tabs at the top and bottom, then twisting gently clockwise to fit them through the openings.
53. Remove all protective packaging and carefully screw the bulb clockwise into the socket.
54. Close the bulb guard by aligning tabs to openings and pressing basket until fully inserted. When inserted, basket will twist counterclockwise and lock into place.
55. Repeat with remaining bulbs.
56. Plug in the power cord.

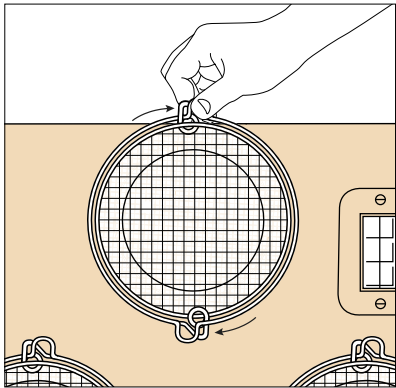

Step 52

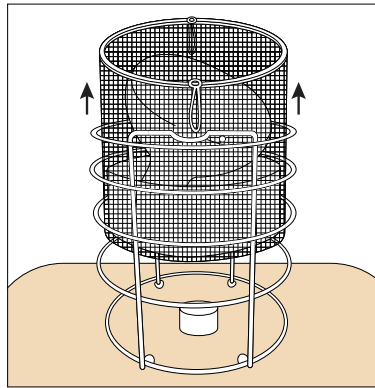

Step 52

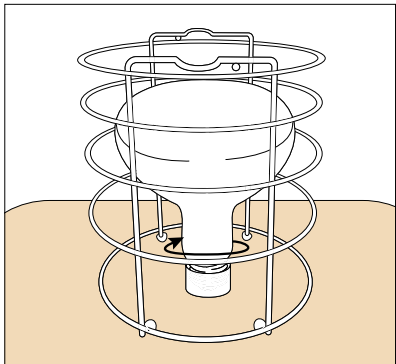

Step 53

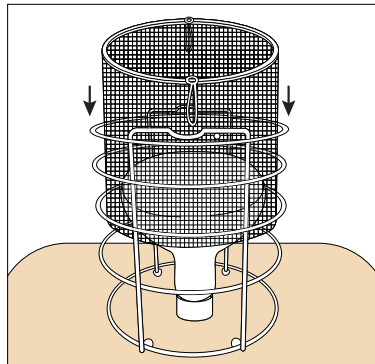

Step 54

# PARTS LIST - Tungsten™

## Tungsten™ Infrared Sauna Panel

---

x1

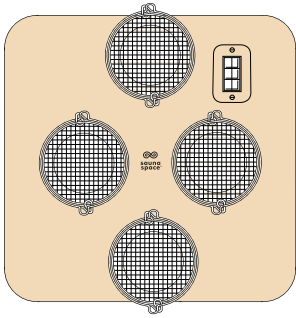

### Tungsten™ Infrared Sauna Panel

23.75 x 23.5 x 9 in  
(60.3 x 59.7 x 22.9 cm)

x4

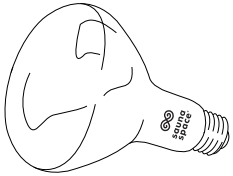

### ThermaLight® Infrared Bulbs

120 V or 240 V

x1

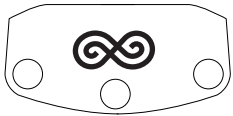

### Power cord grounding sleeve

x1

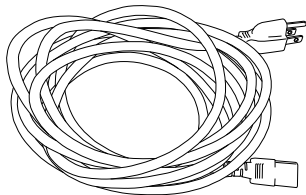

### Shielded power cord

15 ft (4.6 m)

# SPECIFICATIONS

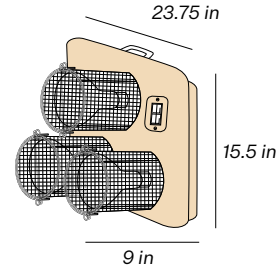

### Weight

3 bulb model: 7 lb (3.2 kg)  
4 bulb model: 11.4 lb (5.2 kg)

### Dimensions

3 bulb model width: 23.75 in (60.3 cm)  
3 bulb model height: 15.5 in (39.4 cm)  
3 bulb model depth: 9 in (22.9 cm)

4 bulb model width: 23.75 in (60.3 cm)  
4 bulb model height: 23.5 in (59.7 cm)  
4 bulb model depth: 9 in (22.9 cm)

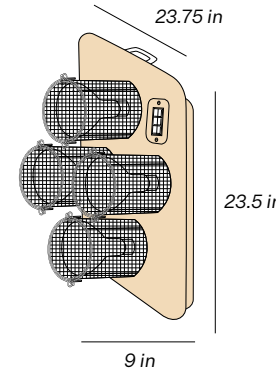

### Electrical info

3 bulb model wattage: 750 W  
4 bulb model wattage: 1000 W  
Input voltage and frequency:  
120 V at 50–60 Hz, 240 V at 50–60 Hz

### Approvals

All electrical parts UL-listed  
CE-certified

# ASSEMBLY - Tungsten™

## Part 1: Mounting

1. Mount your panel using one of the methods below, taking care to align the height with your torso.

### Method 1: Pedestal

Set your sauna panel on your cabinet sauna's built-in bench or use the Tungsten™ Pedestal (available at [sauna.space](http://sauna.space)) to turn almost any small enclosure into a sauna.

### Method 2: Hanging

Use the carrying handle to mount your sauna panel to the wall. Be sure to use proper anchoring hardware for the weight of this device and the structure material.

### Method 3: Sauna Enclosure

Attach your sauna panel to a frame or enclosure by connecting the turn-key mounting clamps to the brackets on the back of the panel. Tighten the clamps around the poles of your frame or enclosure.

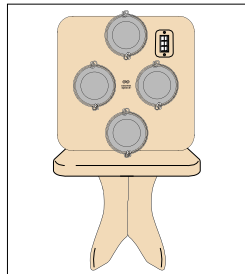

Method 1: Pedestal

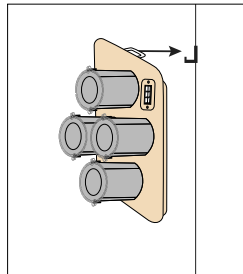

Method 2: Hanging

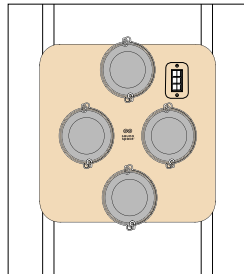

Method 3: Sauna Enclosure

## Part 2: Cord management

2. Open the cord sleeve attached to the sauna panel.
3. Firmly attach the power cable and close the cord sleeve. Do not plug the power cable into the wall yet.

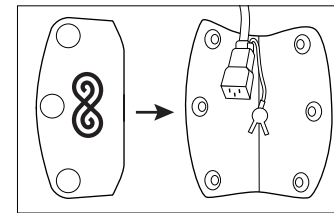

Step 2

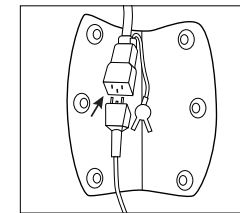

Step 3

## Part 3: Bulb installation

4. On the sauna panel, open the bulb guard basket by holding the tabs at the top and bottom, then twisting gently clockwise to fit them through the openings.
5. Remove all protective packaging and carefully screw the bulb clockwise into the socket.
6. Close the bulb guard by aligning tabs to openings and pressing basket until fully inserted. When inserted, basket will twist counterclockwise and lock into place.
7. Repeat with remaining bulbs.
8. Plug in the power cord.

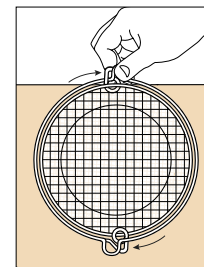

Step 4

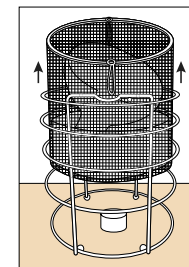

Step 4

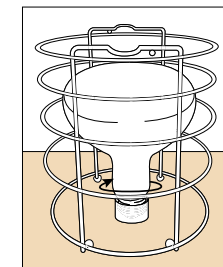

Step 5

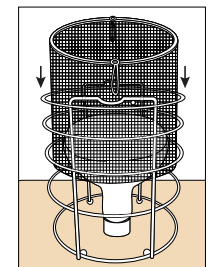

Step 6

# PARTS LIST - Shower Sauna Conversion Kit

## Tungsten™ Infrared Sauna Panel

x1

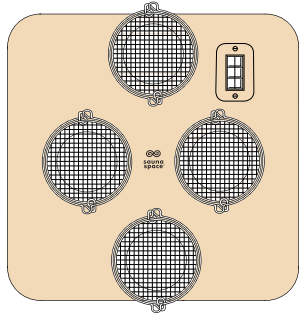

**Tungsten™ Infrared Sauna Panel**  
23.75 x 23.5 x 9 in  
(60.3 x 59.7 x 22.9 cm)

x4

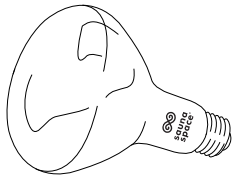

**ThermaLight® Infrared Bulbs**  
120 V or 240 V

x1

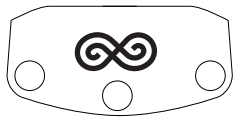

**Power cord grounding sleeve**

x1

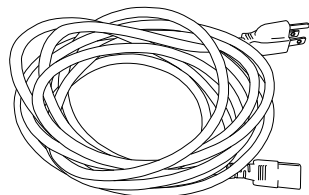

**Shielded power cord**  
15 ft (4.6 m)

## Enclosure

x2



**Shower Curtain Rods**  
Rod length: 40–72 in (102–183 cm)

x1

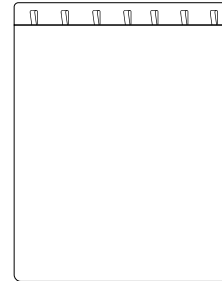

**Shower Curtain**  
Curtain width: 65 in (165 cm)  
Curtain height: 102 in (259 cm)

## Stool & Tungsten™ Pedestal

x1

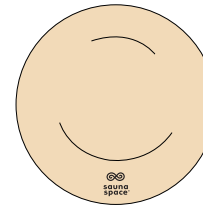

**Stool seat plate**

x1

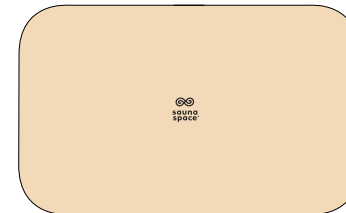

**Pedestal seat plate**

x4

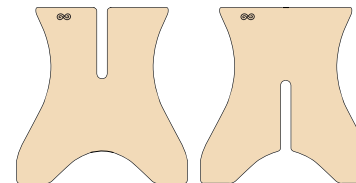

**Leg panels**



# SPECIFICATIONS

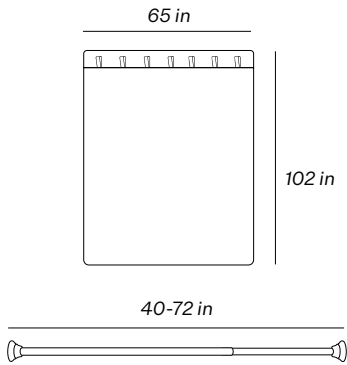

## Weight

Total: 40.2 lb (18.2 kg)  
 Tungsten™ Sauna Panel: 11.4 lb (5.2 kg)  
 Shower Curtain: 7.2 lb (3.3 kg)  
 Shower Rod (each): 1.3 lb (.6 kg)  
 Sauna Stool: 8.5 lb (3.9 kg)  
 Tungsten™ Pedestal: 10.5 lb (4.8 kg)

## Shower Curtain dimensions

Curtain width: 65 in (165 cm)  
 Curtain height: 102 in (259 cm)  
 Rod length: 40–72 in (102–183 cm)

## Tungsten™ Sauna Panel dimensions

Width: 23.75 in (60.3 cm)  
 Height: 23.5 in (59.7 cm)  
 Depth: 9 in (22.9 cm)

## Tungsten™ Pedestal dimensions

Height: 18 in (46 cm)  
 Seat width: 20 in (51 cm)  
 Seat depth: 12 in (30 cm)  
 Leg width: 16 in (41 cm)

## Sauna Stool dimensions

Height: 18 in (46 cm)  
 Seat width: 14 in (36 cm)  
 Leg width: 16 in (41 cm)

## Electrical info

Wattage: 250W  
 Input voltage and frequency:  
 120 V at 50–60 Hz, 240 V at 50–60 Hz

## Approvals

All electrical parts UL-listed  
 CE-certified

# ASSEMBLY - Shower Sauna Conversion Kit

## Part 1: Enclosure

**Note:** Installation may vary based on the design of your shower stall. Use the reference pictures to approximate this setup for your shower.

1. Make sure all surfaces in and around the shower are dry.
2. Bring one curtain rod to the far side (or wall) of your shower, either above or below the height of the shower head.
3. Extend the curtain rod to the length of the wall.
4. Twist the curtain rod three full turns to lock it in place.
5. Repeat steps 2–4 on the near (or open) side of the shower.
6. With straps facing towards you, pull the straps around the rod farthest from you (rear rod) and snap them closed.
7. Drape the curtain over the rod closest to you (front rod). The snaps should face the ceiling.

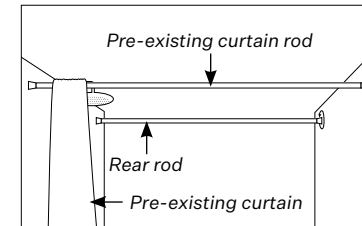

Step 4

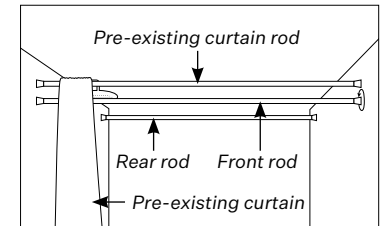

Step 5

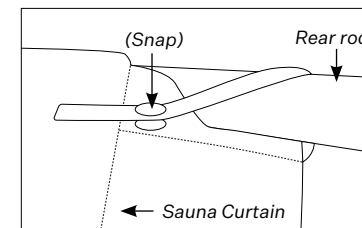

Step 6

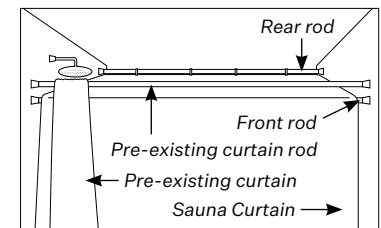

Step 7

## Part 2: Stool

---

8. Gather all parts listed for the Sauna Stool.
9. Align the slots on the leg panels. The two panels should be perpendicular.
10. Press down to attach the leg panels to each other.
11. Set the seat plate on the floor with the x-groove facing up.
12. Set the base of the stool into the x-groove on the seat plate and press down.
13. Turn the stool right side up and press down again.

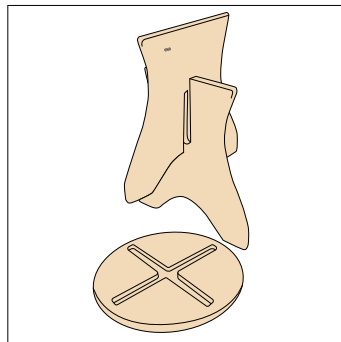

Step 11

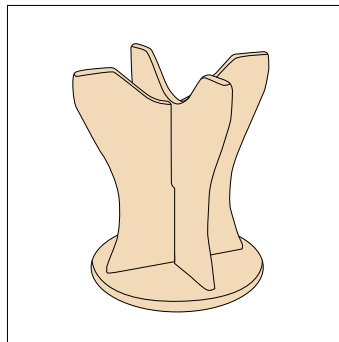

Step 12

## Part 3: Tungsten™ Pedestal

---

14. Gather all parts listed for the Tungsten™ Pedestal.
15. Align the slots on the leg panels. The two panels should be perpendicular.
16. Press down to attach the leg panels to each other.
17. Set the seat plate on the floor with the x-groove facing up.
18. Set the base of the stool into the x-groove on the seat plate and press down.
19. Turn the pedestal right side up and press down again.

**Note:** If the stool or pedestal wobble, the top plate may not be attached completely. Turn the item upright and tap it firmly on the ground to attach the top plate fully.

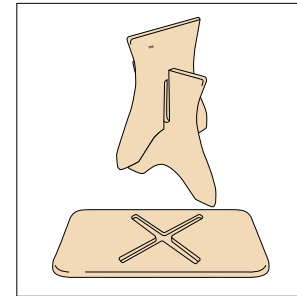

Step 17

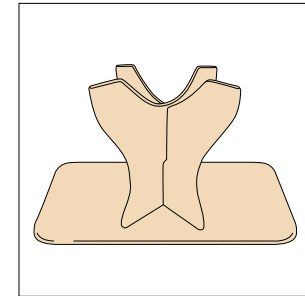

Step 18

## Part 4: Bulb installation

---

20. On the sauna panel, open the bulb guard basket by holding the tabs at the top and bottom, then twisting gently clockwise to fit them through the openings.
21. Remove all protective packaging and carefully screw the bulb clockwise into the socket.
22. Close the bulb guard by aligning tabs to openings and pressing basket until fully inserted. When inserted, basket will twist counterclockwise and lock into place.
23. Repeat with remaining bulbs.
24. Plug in the power cord.

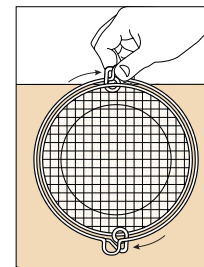

Step 20

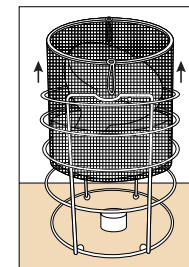

Step 20-21

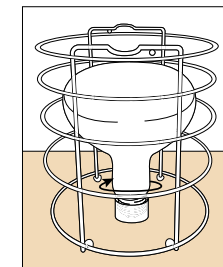

Step 21

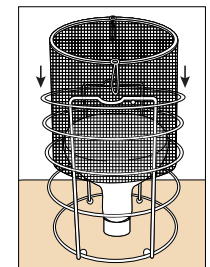

Step 22

## Part 5: Arrangement and cords

---

25. Place the Tungsten™ Pedestal at the faucet-side of the shower.
26. Place the stool at least 18 inches from the pedestal.
27. Set the Tungsten™ Infrared Sauna Panel on top of the Tungsten™ Pedestal with bulbs facing the stool.
28. Open the cord sleeve attached to the sauna panel.
29. Attach the power cable and close the cord sleeve.
30. Plug the power cord into the wall.

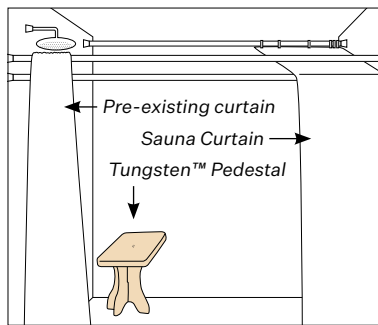

Step 25

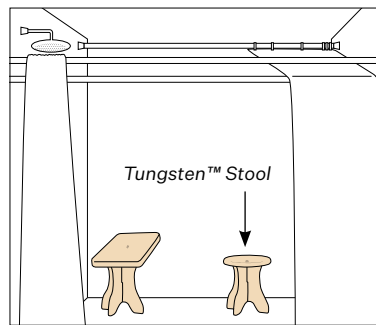

Step 26

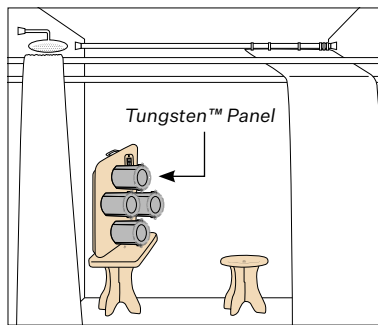

Step 27

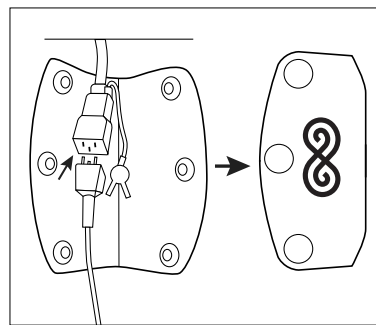

Step 29

# OPERATIONS

Please read the whole operations guide before use.

The goal of sauna therapy is to raise your body's core temperature and create a whole-body sweat response. It will take a different length and frequency of sessions to achieve those goals for each individual. For some people it only takes a few days to adjust to the sauna, while others may take longer.

## Session length

Figure out what length feels best for you over time.

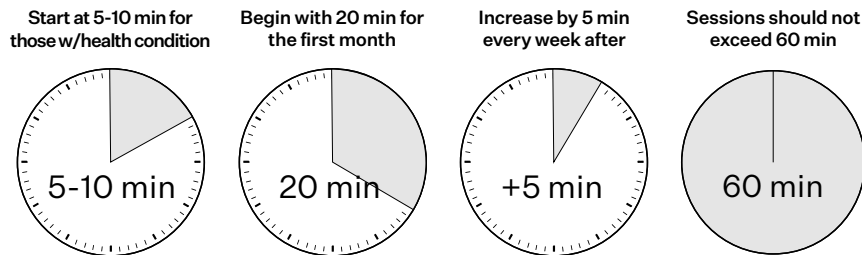

For use by minors, the general rule for session length is 1 minute per year of age with adult supervision.

## Frequency

Start your sauna therapy with one session per day, three days per week, for at least the first month. Those with a health condition, start gently with one or two sessions per week. After you have figured out what session length works for you, try increasing the frequency. Do not exceed two sessions per day.

## Time of day

You can use your sauna anytime, but you may see better results by incorporating it into your morning or bedtime routine. Because your body is more relaxed during these times, it will sweat and detoxify more efficiently.

## Supervision

If you have any type of health condition or risk, it can be helpful to have a friend or attendant nearby. If no one is available, schedule a time for someone to check in over the phone.

## Before your session

1. Check that the sauna panel is level and aligned with your torso.
2. Optional: turn on the sauna panel to preheat the sauna for 5–10 minutes before starting.
3. Drink one or two glasses of water.
4. Optional: consider dry brushing the skin to enhance your results.
5. Place a towel on the stool and another beneath your feet to protect sauna materials.\*
6. Remove clothing.\*\*
7. Remove jewelry, devices, and distractions.\*\*\*

\*Sweating directly on the components of the sauna may cause damage and void the warranty.

\*\*Full-body exposure is ideal, but you may choose to wear underwear, swimsuit bottoms, or cover implants with clothing or a towel.

\*\*\*We do not recommend using essential oils, body lotions, or devices like phones or smartwatches in the sauna. If you must bring a device into the sauna, put it in airplane mode and turn off Wi-Fi and Bluetooth.

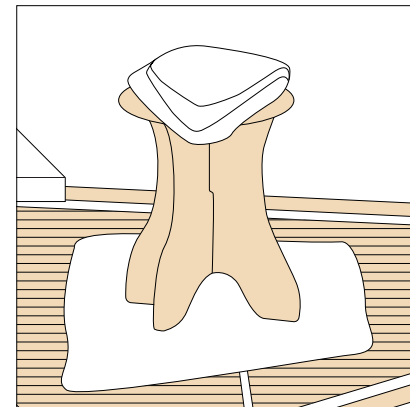

Step 5

## During your session

1. Customize the intensity of your session. Each switch controls different bulbs.

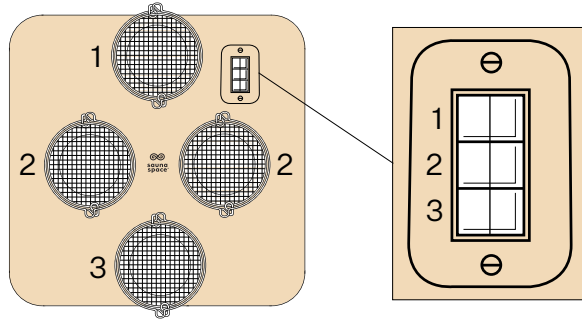

2. If you purchased a sauna, seal the curtain from the inside.

**At the top:** hook the inner curtain loops onto the wooden toggles on each side of the opening.

**At the bottom:** snap the grounding mat tab into the curtain on at least one side of the opening.

Tuck the sides of the curtain behind poles.

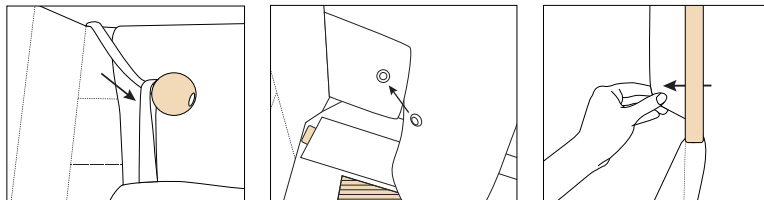

Step 2 (At the top)

Step 2 (At the bottom)

Step 2 (Tuck the sides)

## Positioning

1. During your session, align your torso to the sauna panel and seat yourself 18-36 inches from the front of the panel for optimal results.
2. Rotate one-quarter turn or one-half turn every 2-10 minutes for even exposure and comfort.

3. Try to sweat for at least 5 minutes before ending your session. If you feel unwell for any reason, end your session immediately.

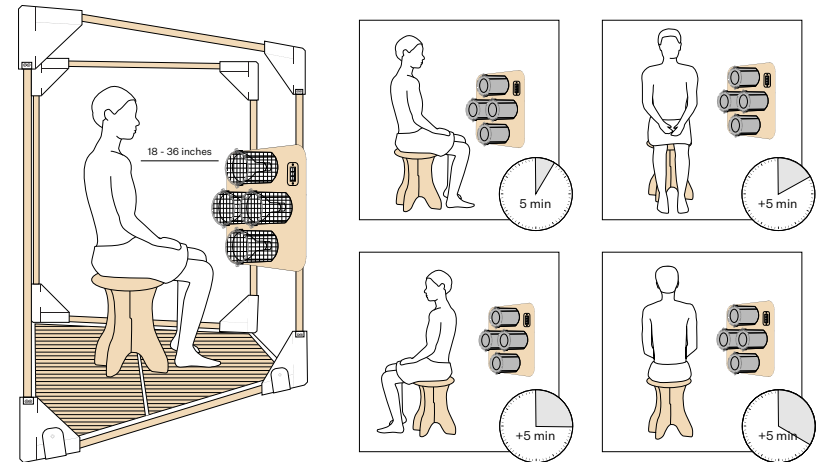

## After your session

1. Immediately after use, wipe sweat from your hands and arms before turning off the sauna panel.
2. Remove towels from the sauna.\*
3. Drink one or two glasses of water.
4. Wipe the sweat off your skin with a towel or rinse off in a warm or cool shower.
5. Optional: consider wet brushing the skin during your shower.
6. Take 10-20 minutes to rest before returning to your day.

\*Leaving damp towels directly on the components of the sauna may cause damage and void the warranty.

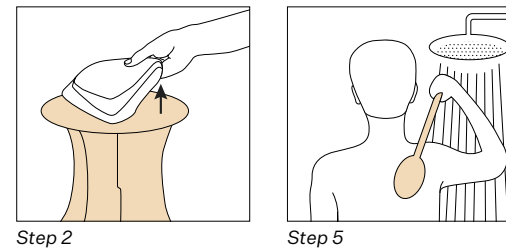

Step 2

Step 5

# MAINTENANCE

## **Tungsten™ Infrared Sauna Panel**

Protect unfinished wood from water and humidity. Dry with a cloth immediately if exposed to moisture.\*

## **Frame**

Protect canvas and unfinished wood from water and humidity. Dry with a cloth immediately if exposed to moisture.\*

## **Inner and outer cover**

Machine washable. Use the delicate cycle and a gentle hypoallergenic detergent. Hang dry or use the air dry setting on your dryer. Steam covers to reduce wrinkling. Pay attention to your steamer's settings to avoid discoloring or damaging the material.

## **EMF Shield**

Hand wash with a gentle pH-neutral soap in cold water. Hang to dry. Do not soak, machine-dry, steam, or dry clean.

## **Stool**

Protect unfinished wood from water and high humidity. Dry with a cloth immediately if exposed to moisture. Place a towel on your stool during sauna sessions to protect it from sweat.\*

## **Grounding mat**

Protect unfinished bamboo and canvas from water and humidity. Spot clean with a 1:1 solution of distilled white vinegar and water. Place a towel on the bamboo floor during sauna sessions to protect it from sweat.\*

## **Bulbs**

Replacement ThermaLight® bulbs may be purchased from SaunaSpace® at sauna.space. Select 120 V bulbs for use in the US, Canada, Japan, or Taiwan. Choose 240 V bulbs for use in the UK, Australia, the Middle East, and Europe. If you are unsure which bulb is for you, contact hello@sauna.space.

\*Sweat and moisture may lead to damage that voids your warranty.

# RETURNS

## 100-day home trial

---

Discover if SaunaSpace® is right for you with our stress-free 100-day home trial. No obligations. Just full-body rejuvenation. Your trial starts on the day of delivery.

Summary of limitations:

- Refurbished items are not eligible for home trial.
- Claims for items missing or damaged in transit must be received within five (5) business days of receipt of product.
- Refunds on returned products will only be issued to the original payment method.
- We are not responsible for damaged packages. But, if the shipping carrier damages your packages, we will handle the claim process for you and arrange for replacement items to be sent to you.
- We are also not responsible for lost packages. That's why we ship Signature-Required by default. If you elect to have your shipment delivered without a signature requirement, it is your responsibility once the shipment is marked delivered by the carrier.
- All returned or exchanged items will be inspected upon return:
  - Items returned to us in "like-new" condition will be fully refunded. "Like-new" means in the condition in which the items were received: free of pet hair, dirt, stains, fragrance contamination, etc.
  - Do not wash any fabric products; washed items are not eligible to be returned.
  - Identified damages due to user abuse or improper packing may result in prorated reduction of refund amount.
  - Failure to use towels to prevent sweat from reaching the product may lead to damage that may result in a prorated reduction of refund amount. This is relevant for purchases that include a Bamboo Grounding Mat, such as Luminati® Infrared Sauna, Faraday® Infrared Sauna and Sauna Enclosure Kit.



- We are not responsible for personal data or items left in returned merchandise.
- We are not responsible for any consequential or incidental damage resulting from the sale or use of any product bought from us. We are responsible for the monetary value of the product only.
- You must complete your return drop-off or pickup within fourteen (14) days of receipt of your return ship labels. Otherwise, your return request will be canceled.

## Returns

---

Products in “like new” condition are eligible for free return shipping within the contiguous US and Canada. International return shipping will be deducted from the amount of your refund and may not be eligible for pickup services.

If you don’t love your SaunaSpace® product, follow these simple steps within the return period:

Email [hello@sauna.space](mailto:hello@sauna.space) with your order number, the items you’re returning, and if you would like to drop off the package with your carrier or have it picked up.

Within two business days, we will send you a prepaid return shipping label and instructions for repackaging your items.

Ship your items within 14 days after receiving shipping labels. We’ll issue your refund 1–5 days after receipt and inspection. Please allow up to 14 days for the credit to appear on your credit card statement.

Refurbished items are not eligible for returns.

Note: All information provided in this manual may be subject to change. For full details about our 100 day home trial and return shipping, visit [sauna.space/shipping-and-returns](http://sauna.space/shipping-and-returns).

## WARRANTY

SaunaSpace® recognizes that certain naturally varying materials such as wood, cotton, bamboo, and glass used in its Products have naturally occurring blemishes, minor imperfections, and weave asymmetry. These naturally occurring irregularities are not considered defects in materials for the purpose of this warranty, provided they do not adversely affect the functionality of the Product.

SaunaSpace® warrants to the original customer purchaser that its Products will be free from defects in materials and workmanship appearing under normal individual consumer use for the time period(s) listed below. This warranty does not cover damage to Products caused by abuse, acts of God, theft, loss, mishandling, unauthorized modification or repair, or failure to consult a licensed health care provider regarding proper use of this product.

This warranty is in lieu of all other express warranties and any implied warranties, including but not limited to any implied warranty of merchantability or fitness for particular purpose, are limited to the duration of this warranty. In no event will SaunaSpace® be liable for any incidental or consequential damages.

Some states do not allow limitations on how long an implied warranty lasts and/or the exclusion or limitation of incidental or consequential damages, so the above limitation and/or the above exclusion may not apply to you. This warranty gives you specific legal rights, and you may also have other rights which vary from state to state. As its sole responsibility and your sole remedy for any warranted defect, SaunaSpace® will repair or replace any defective part of its Products, containing a warranted defect, free of charge, and with notification within six months following the discovery of such defect.

## Warranty coverages

---

<b>Period</b>	SaunaSpace® Product
<b>10 years</b>	<ul style="list-style-type: none"><li>• Faraday® Infrared Sauna (excludes EMF Shield)</li><li>• Luminati® Infrared Sauna</li><li>• Tungsten™ Infrared Sauna Panel</li><li>• Photon™ Infrared Therapy Light</li><li>• Sauna Stool</li><li>• Tungsten™ Pedestal</li><li>• Shower Sauna Conversion Kit</li><li>• Photon™ Soft Case</li><li>• Photon™ Desk Arm</li><li>• Sauna Enclosure Kit</li><li>• Sauna Travel Bag Set</li><li>• Sauna Cover Set</li></ul>
<b>5 years</b>	EMF Shield
<b>2 years*</b>	ThermaLight® bulbs (120 V and 240 V)  *If your ThermaLight® bulbs are used in any non-SaunaSpace® Product, the warranty is limited to 1 year.

## In-warranty repairs

---

Our handmade products are built with strict quality controls and should last many years if cared for properly. But we also make it easy to get repairs when you need to exercise your warranty.

1. Contact [hello@sauna.space](mailto:hello@sauna.space) to tell us about your needs.
2. Ship your products to our shop.
3. We will repair or replace the necessary parts within 5–10 business days of receiving your shipment.
4. We will email you a tracking number once we have shipped your items.

Please note that in certain cases we may ship replacement parts to you instead of performing repairs in our shop.

## Out-of-warranty repairs

---

Even after the warranty expires, we want to help you get the most out of your products. Non-warranty repairs are simple:

1. Contact [hello@sauna.space](mailto:hello@sauna.space) to tell us about your needs.
2. Ship your products to our shop. Customers are responsible for shipping costs both ways.
3. We will repair or replace the necessary parts within 5–10 business days of receiving your shipment.
4. We will bill you for the cost of repairs.
5. We will email you a tracking number once we have shipped your items.

If we ship you replacement parts instead of performing repairs in our shop, the customer is responsible for the cost of parts and shipping.



saunaspace®

## We're here to help

sauna.space  
hello@sauna.space

+1-573-66SAUNA (+1-573-667-2862)  
8 a.m.–5 p.m. Central Time  
Monday–Friday, excluding holidays

Headquarters:  
1330 East Prathersville Rd  
Columbia, Missouri 65202 USA

Showroom:  
905 Clinkscapes Rd  
Columbia, Missouri 65203 USA